

PERGOLA DETAILS

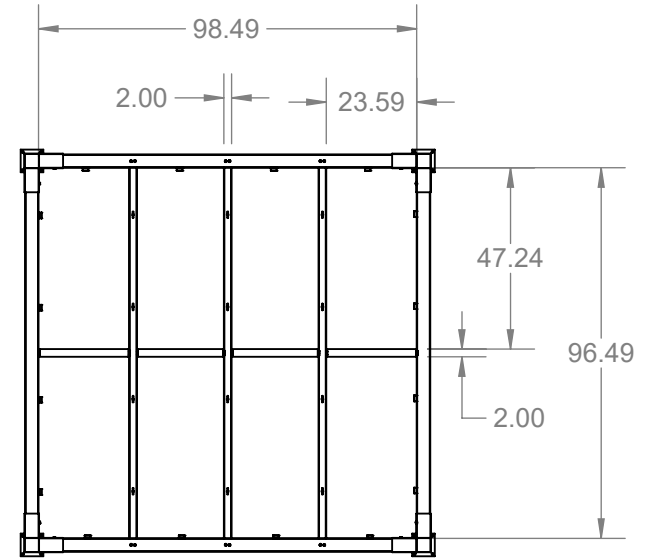

ROOF DETAILS

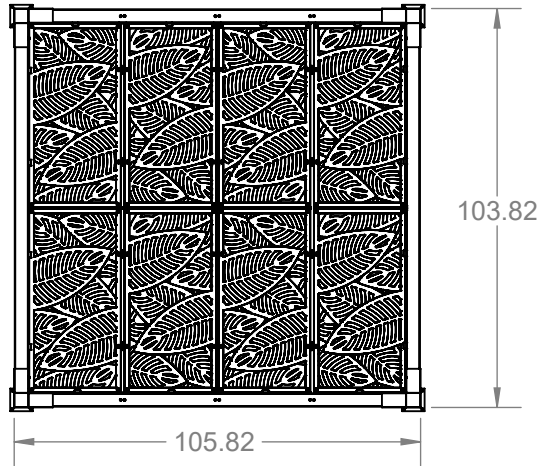
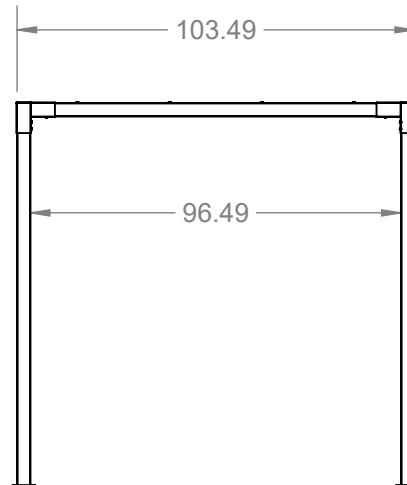
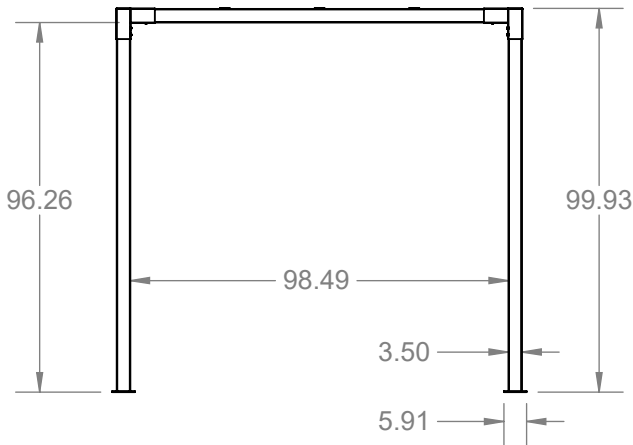

THE INFORMATION CONTAINED IN THIS DRAWING IS PROTECTED BY COPYRIGHT AND PATENT LAWS OF THE UNITED STATES AND OTHER COUNTRIES. ANY REPRODUCTION IN PART OR AS A WHOLE WITHOUT WRITTEN PERMISSION IS PROHIBITED.

Barrette OUTDOOR LIVING		
DRAWN: EP	DATE: 02/08/2023	APPROVED:
DESCRIPTION: PERGOLA DETAILS		
SHEET 1 OF 4	REVISION	PART NUMBER
SCALE 1:50	0	N/A
WEIGHT: 162.63		

PERGOLA PROFILES

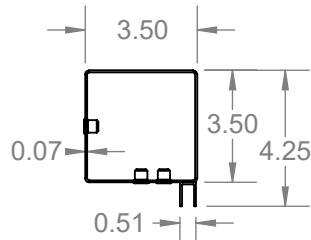

ROOF BEAM

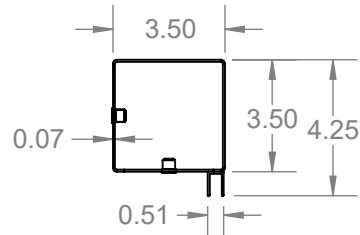

ROOF BEAM W/
JOIST CUTOUTS

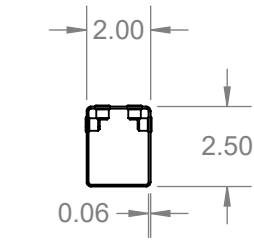

ROOF JOIST

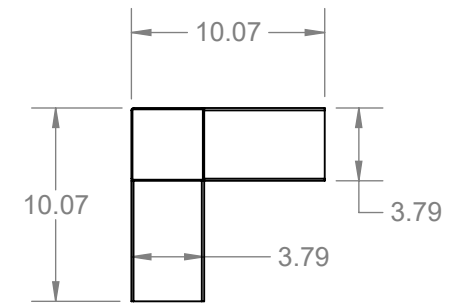

CORNER BRACE

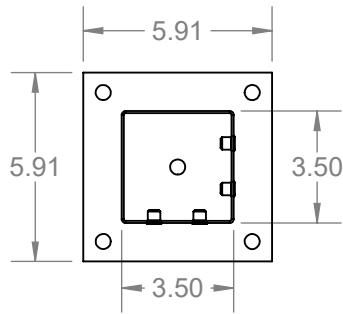

POST



DSP MID SUPPORT

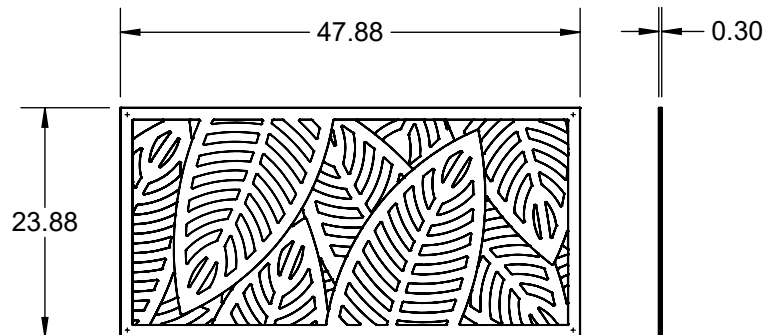
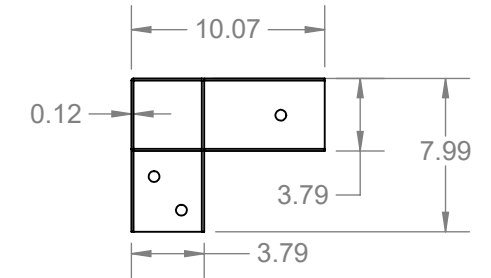

DSP BOARD

THE INFORMATION CONTAINED IN THIS DRAWING IS PROTECTED BY COPYRIGHT AND PATENT LAWS OF THE UNITED STATES AND OTHER COUNTRIES. ANY REPRODUCTION IN PART OR AS A WHOLE WITHOUT WRITTEN PERMISSION IS PROHIBITED.

Barrette OUTDOOR LIVING		
DRAWN: EP	DATE: 02/08/2023	APPROVED:
DESCRIPTION: PERGOLA PROFILES		
SHEET 2 OF 4	REVISION	PART NUMBER
SCALE 1:20	0	N/A
WEIGHT: 8.36		

PERGOLA WALL DETAILS

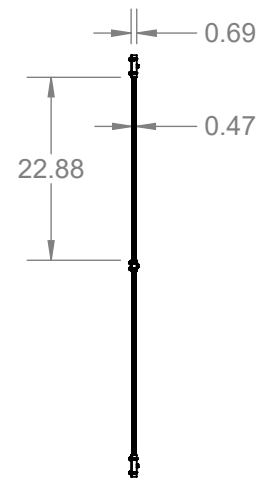
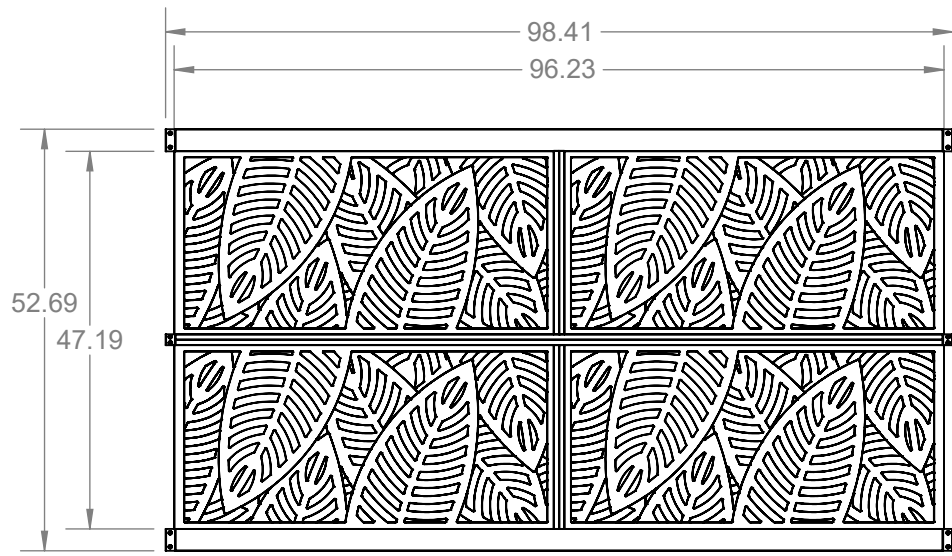

PERGOLA WALL PROFILES

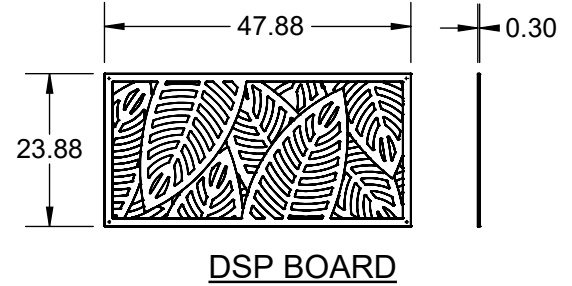
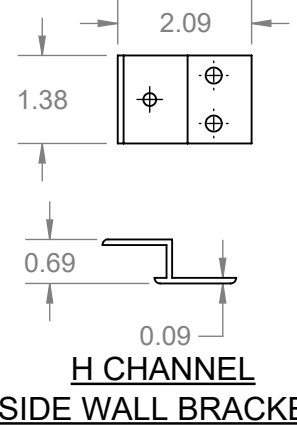
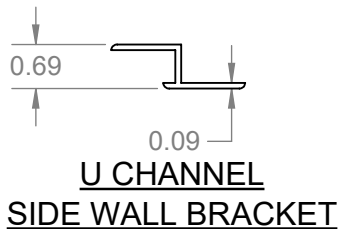
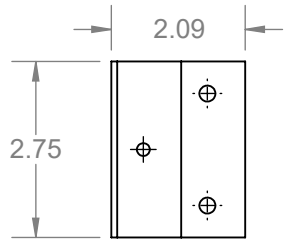
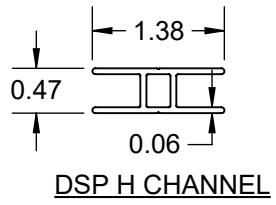
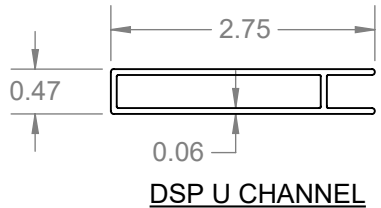

THE INFORMATION CONTAINED IN THIS DRAWING IS PROTECTED BY COPYRIGHT AND PATENT LAWS OF THE UNITED STATES AND OTHER COUNTRIES. ANY REPRODUCTION IN PART OR AS A WHOLE WITHOUT WRITTEN PERMISSION IS PROHIBITED.

Barrette OUTDOOR LIVING		
DRAWN: EP	DATE: 02/08/2023	APPROVED:
DESCRIPTION: PERGOLA WALL DETAILS		
SHEET 3 OF 4	REVISION	PART NUMBER
SCALE 1:24		N/A
WEIGHT: 36.81		

PERGOLA POST AND SURFACE MOUNT DETAILS

NOTE: IMAGES ONLY REFERENCE 2" AND 2.5" POSTS.

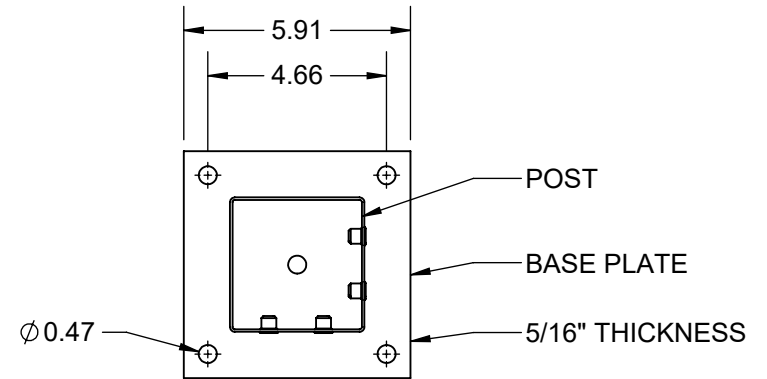

POST BASE CONNECTION INTO CONCRETE WITH WEDGE ANCHORS

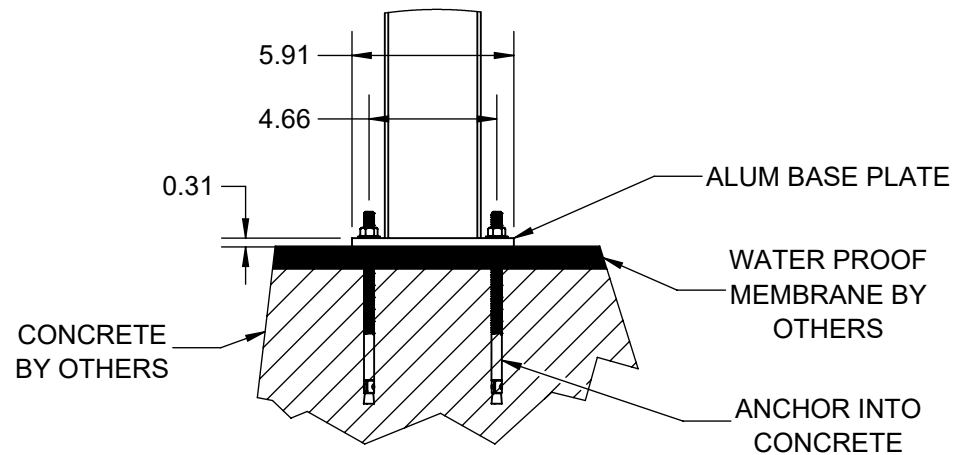

POST BASE CONNECTION INTO WOOD WITH THROUGH BOLTS

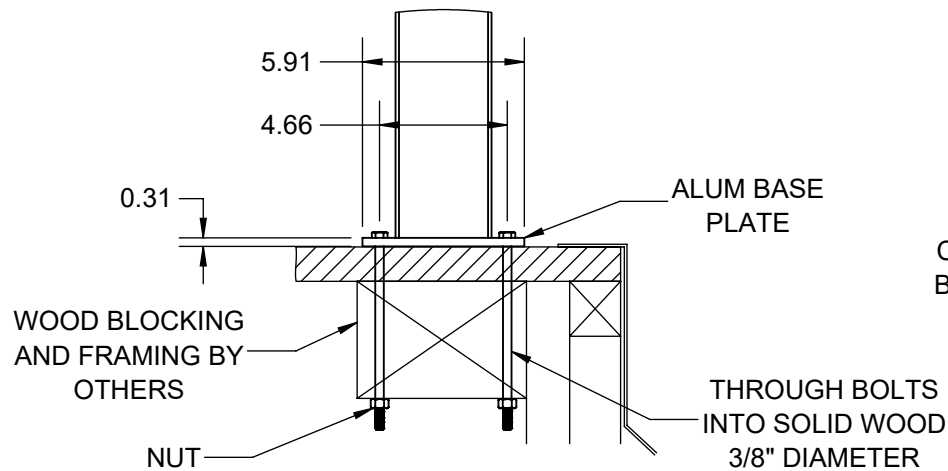

NOTE:

1. COMMERCIAL APPLICATIONS ARE ALWAYS BOLTED, USE 3/8" DIAMETER A307 THROUGH BOLTS INTO SOLID WOOD BLOCKING.
2. WOOD BLOCKING BY OTHERS.
3. BLOCKING MUST BE DESIGNED TO WITHSTAND PROPER LOADING.

THE INFORMATION CONTAINED IN THIS DRAWING IS PROTECTED BY COPYRIGHT AND PATENT LAWS OF THE UNITED STATES AND OTHER COUNTRIES. ANY REPRODUCTION IN PART OR AS A WHOLE WITHOUT WRITTEN PERMISSION IS PROHIBITED.

Barrette OUTDOOR LIVING		
DRAWN: EP	DATE: 02/08/2023	APPROVED:
DESCRIPTION: PERGOLA POST AND SURFACE MOUNT		
DETAIL		
SHEET 4 OF 4	REVISION	PART NUMBER
SCALE 1:16		N/A
WEIGHT: N/A		