



Aluminum Fence Pre-Assembled Fence

For Standard & Heavy-Duty Series

INSTALLATION INSTRUCTIONS



Read all instructions prior to installing product.

Refer to manufacturers safety instructions when operating any tools.

To register your product, please visit:

freedomproduct.com

⚠ WARNING:

- Improper installation of this product can result in personal injury. Always wear safety goggles when cutting, drilling and assembling the product.
- Incorrect installation may cause harm to the product or individual.
- Not pool code approved.

NOTICE:

- DO NOT attempt to assemble the kit if parts are missing or damaged.
- DO NOT return the product to the store. For assistance or replacement parts call: 1-800-336-2383.

BEFORE YOU BEGIN:

Check your local zoning laws.

- Local zoning laws and Home Owners Associations may regulate the location, style and height of your fence or even require a permit signoff beforehand.
- Check local codes for frost line depth and regulations.

Contact your local utilities companies.

- You must have the utility companies clearly mark your property for electrical, gas or water lines to avoid puncturing any unseen underground utilities.

TOOLS NEEDED:

String & Stakes
Tape Measure
Post Hole Digger
Shovel
Level
Hacksaw
Rubber Mallet
Gravel/Filler (6" per hole)
Concrete Mix
Safety Glasses

Fencing Components:

Description
Top Rail
GrippLok™ Locking Strips
Middle Rail*
Bottom Rail
Pickets

*Included with certain styles.

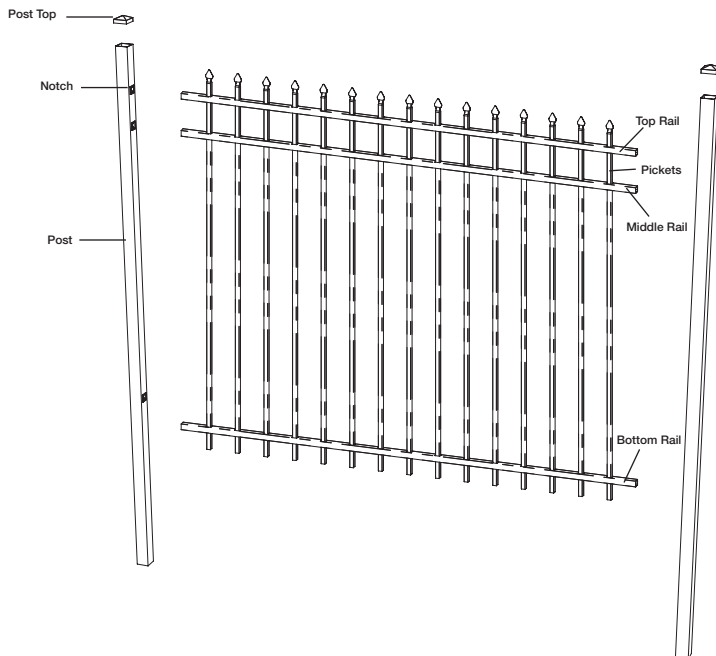

1

Layout Installation:

- Establish your fence line by staking out the areas you wish to enclose. Locate each point in which you will need an end, corner or gate post and mark it with a stake (Fig. 1).
- For 6' sections using 2" posts: measure $72\frac{3}{4}"$ from the center of an end point and mark with stake (Fig. 2).

NOTE:

- Installing on sloped terrain will reduce distance between posts.
- If you are left with a space less than a full panel, the panel can be cut down to fit the space by using a hacksaw. "Notch" the cut ends of the horizontal rails so they will sit inside of post.
- Attach string to each stake to provide straight guide lines.
- Plan gate placement, opening and hardware clearance before installing fencing.

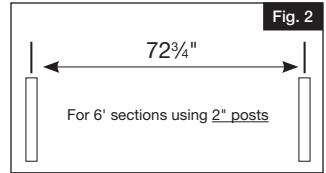
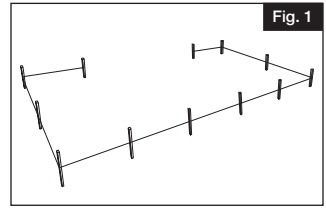

2

Post Top Installation:

Use a rubber mallet to gently drive the post tops onto the posts (sold separately). Be careful not to damage the post top (Fig. 3).

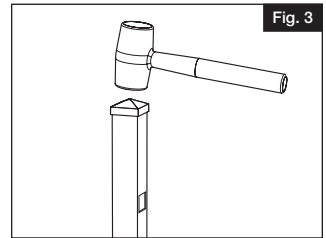

3

Post Location:

Measure the width of the fence panel (X) plus the width of the post (Y). This is the common center-to-center measurement (unless there is a cut-down panel) for post hole location (Fig. 4).

Post Installation:

Dig first two post holes 6" in diameter and down to your specified frost line. Insert filler/gravel into the bottom of both holes and then set first post in post hole.

Add wet or dry concrete mix according to the manufacturer's instruction to the top of the hole for first post only and level it.

Example: When your frost line is 36" insert 12" of gravel/ filler and 24" of post with concrete surrounding (Fig. 5).

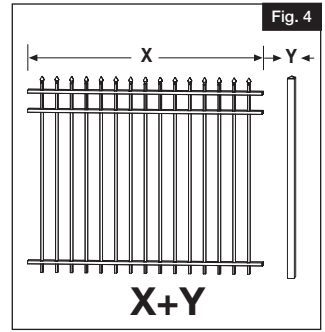

4

Gate Installation:

The opening between the posts should be 1½" wider than the gate width to allow for hinges. (Example: Use a 48" opening for a 46½" wide gate.) Be sure posts are level and plumb.

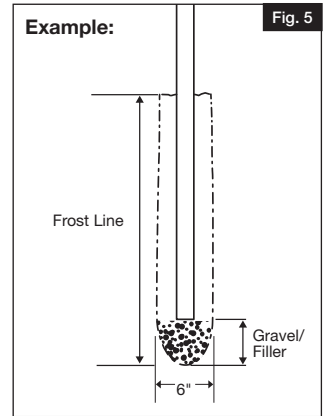

4

1

Panel/Post Installation:

As the post is setting up, install the first fence panel. Insert the horizontal rails from the panel into the punched holes from the previously installed post. Place the rails as far into the post as they will go (Fig. 1).

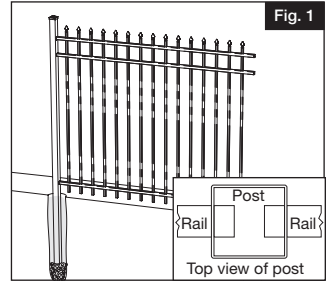

2

Place the next required post into the dug hole, and slide the post onto the rails of the panel as far as possible.

Plumb and level the post and add concrete according to manufacturer's instructions.

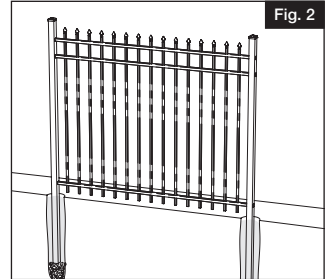

3

After setting first fence section, proceed systematically with post, panel, post, etc. (Fig 3).

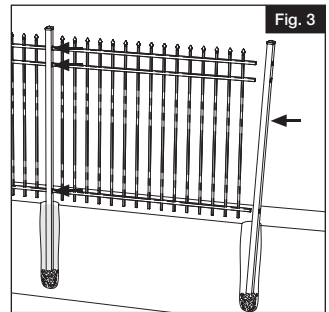

4

After concrete has set, fasten the fence section to the posts using #8 x 1" self-tapping screws (Fig. 4).

IMPORTANT:

Be careful not to over-tighten screws.

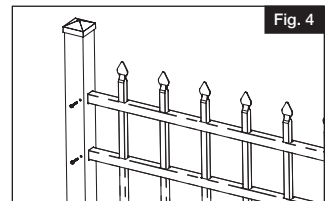

Barrette Outdoor Living
545 Tilton Rd, Egg Harbor City, NJ. 08215
freedomproduct.com • (888) 418-4400

